

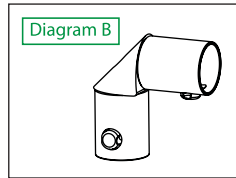

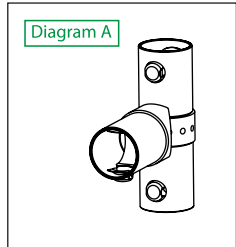

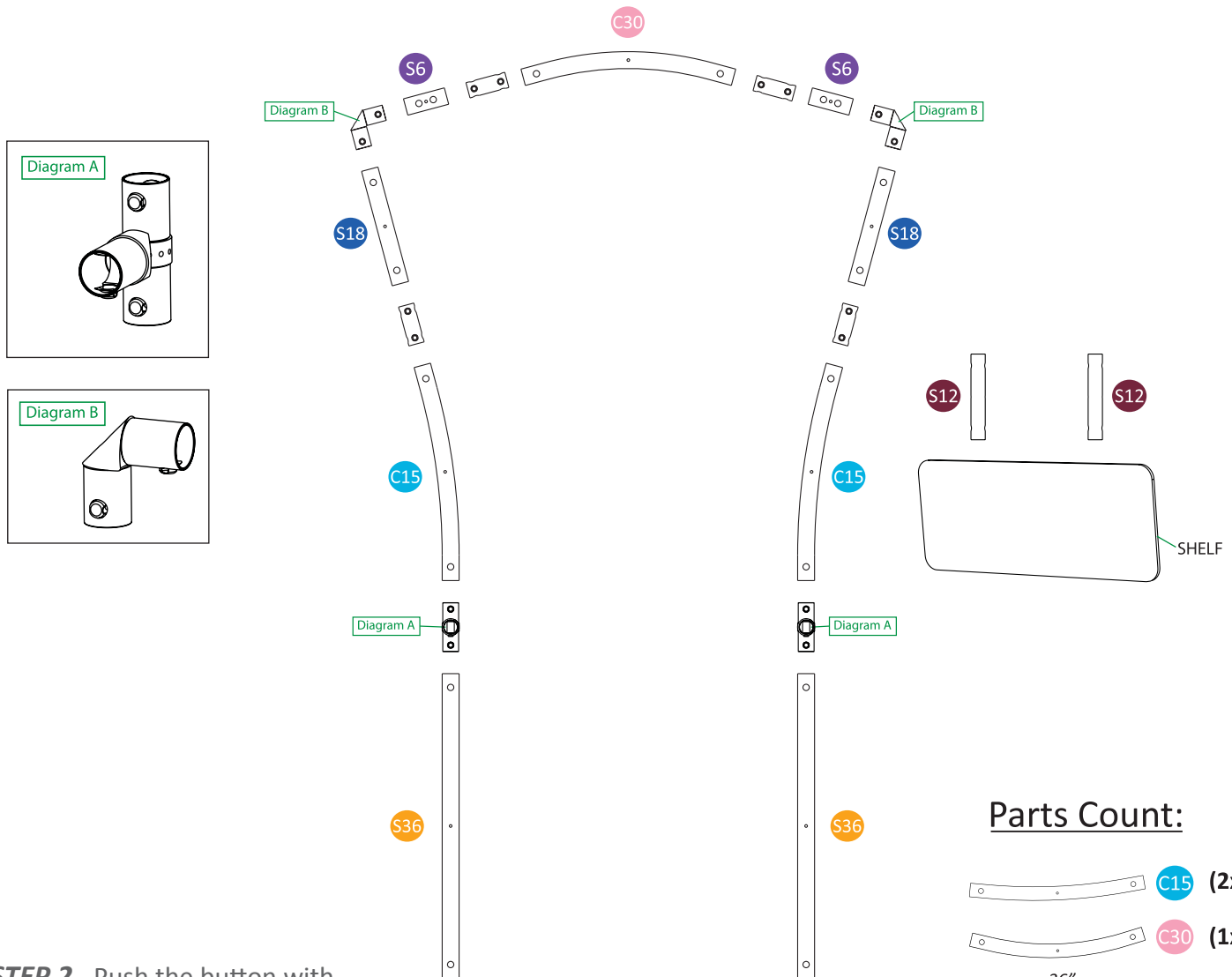

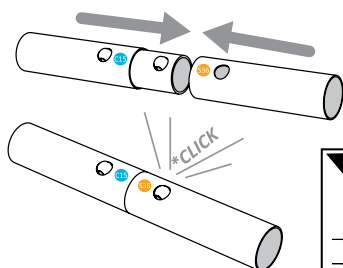

STEP 1. Layout all the parts on the floor in this form. Assembly of the tubes will be flat on the floor. The Base Plate, Shelf, and S12 support poles will be attached after the graphic is installed.

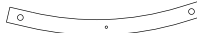
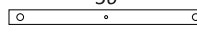

STEP 2. Push the button with your thumb while sliding the tubes together. Twist as needed to click the button into the hole.



Parts Count:

-  **C15 (2x)**
-  **C30 (1x)**
-  **S36 (2x)**
-  **S18 (2x)**
-  **S12 (2x)**
-  **S6 (2x)**
-  **Diagram A (2x)**
-  **Diagram B (2x)**
- BASE PLATE (1x)**
- SHELF (1x)**

STEP 3. The main frame is assembled, without the Base Plate, and Shelf or VESA Mount. Starting at the bottom of the frame, slide the zipper end of the graphic upwards towards the top. If your frame has Shelf or VESA options, be careful not to snag the fabric on the attachments. The Base Plate is attached after the graphic is zipped closed.

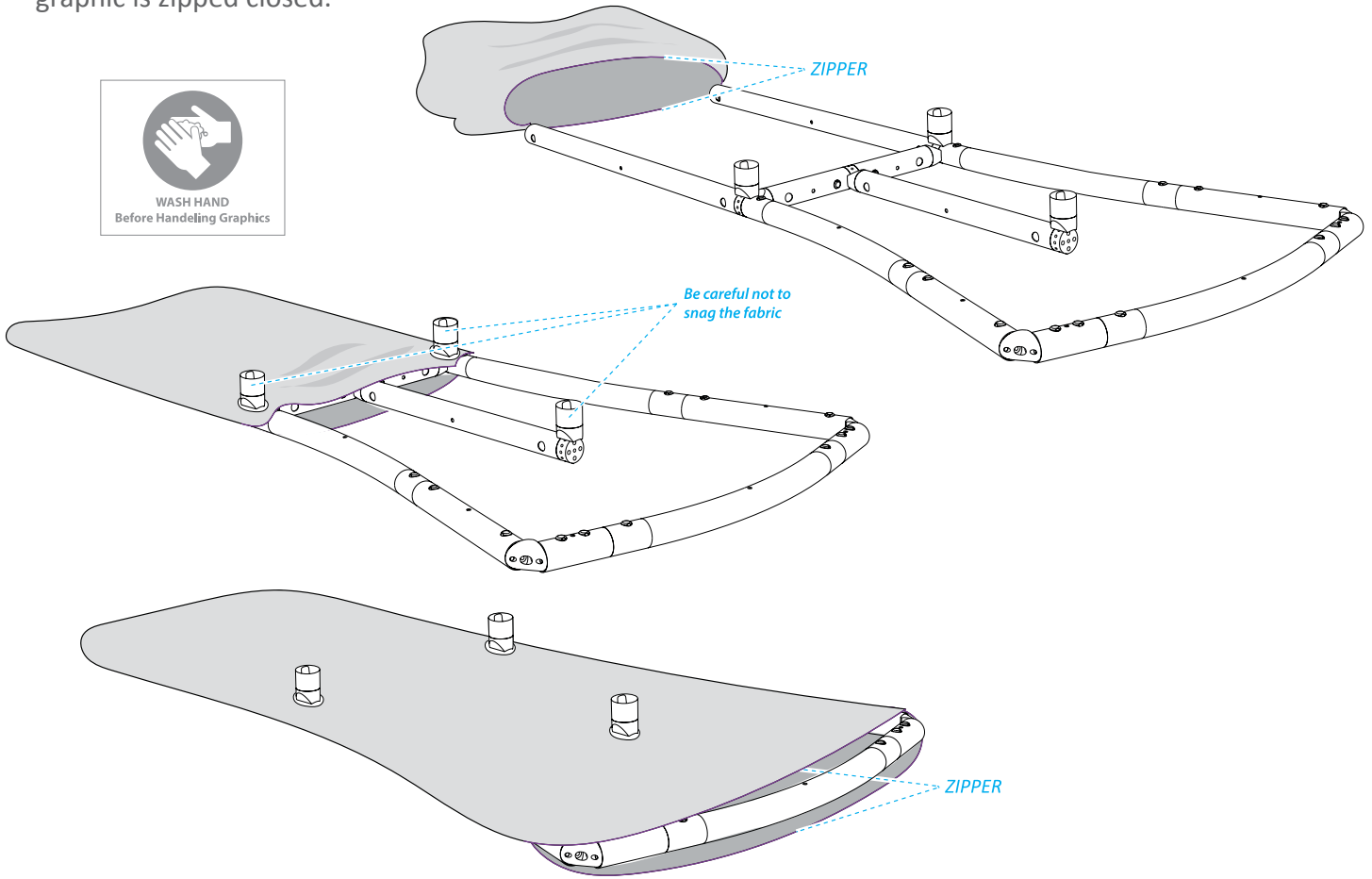

STEP 4. Install the (2) S12 shelf supports. The bottom of the shelf has rubber tabs that align with the holes in the S12 supports. Velcro is used for extra support.

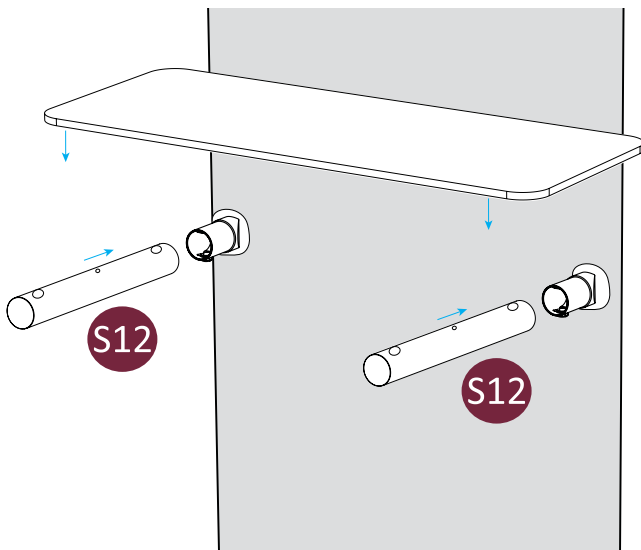

ASSEMBLED VIEW:

