

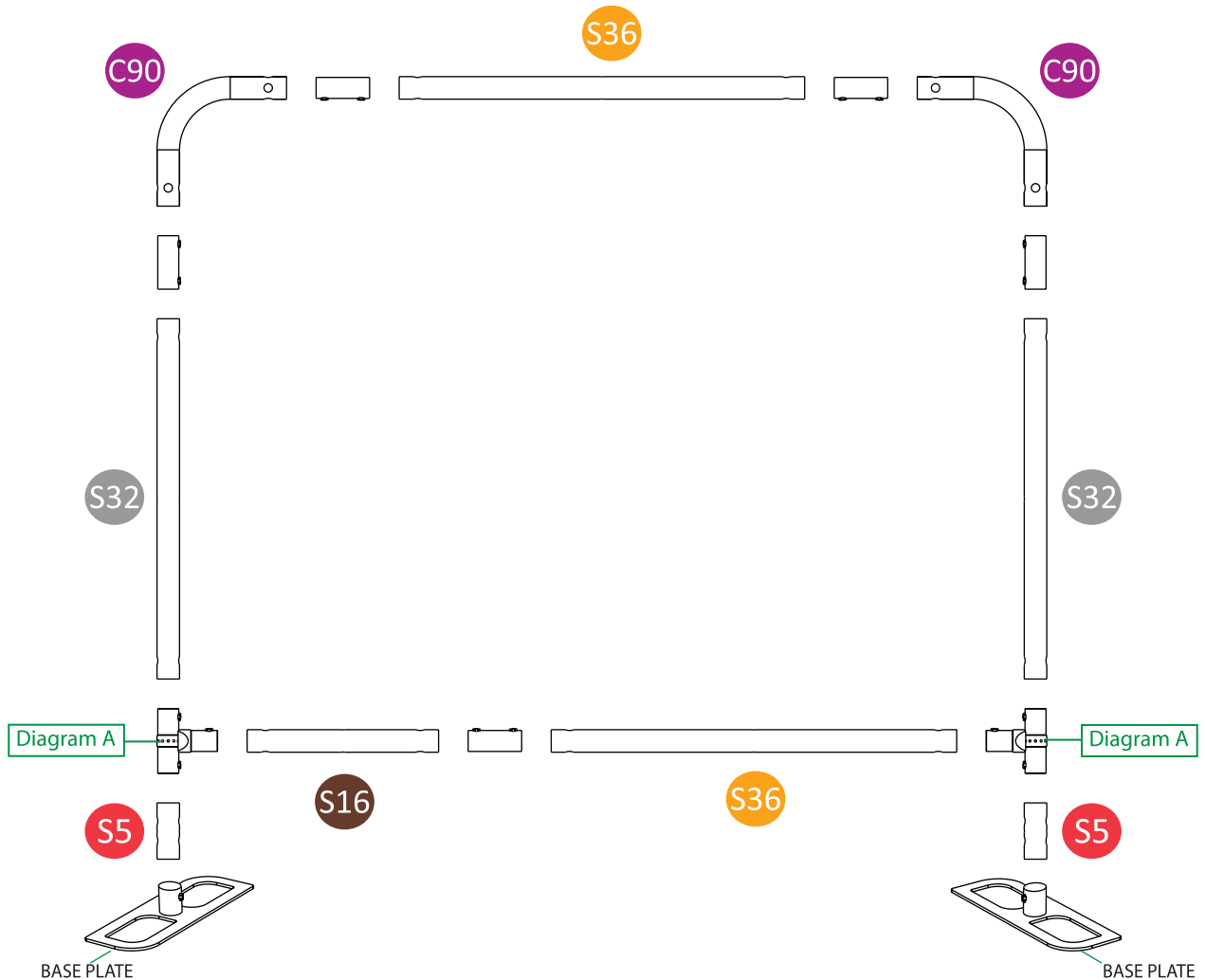

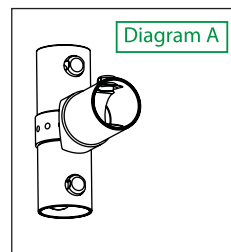

STEP 1. Layout all the parts on the floor in this form. Assembly will be done flat on the floor, not standing up. Snap the bottom Base Plates into place last.

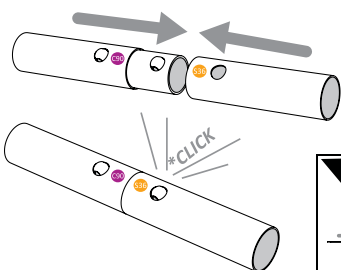

STEP 2. Push the button with your thumb while sliding the tubes together. Twist as needed to click the button into the hole. Some buttons may already be inserted into one end of each tube. Face all buttons towards the inside of the frame. Stickers are next to the correct button hole.

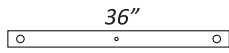
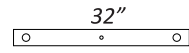
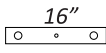

Parts Count:

-  **C90 (2x)**
-  **S36 (2x)**
-  **S32 (2x)**
-  **S16 (1x)**
-  **S5 (2x)**
-  **Diagram A (2x)**
- BASE PLATE (2x)**

STEP 3. With the completed frame laying down on the floor, begin installing the graphics sliding the fabric over the top corners of the frame, like a pillow case. Switching from the right and left side, slide the fabric down a little bit at a time. The display is ready to stand up after the graphic is installed.

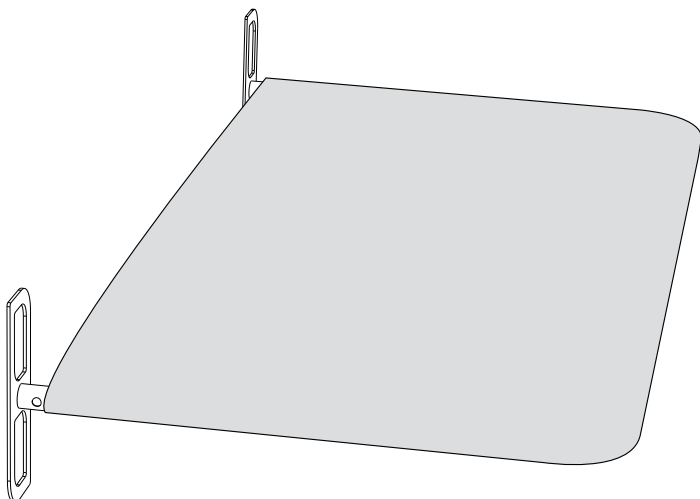
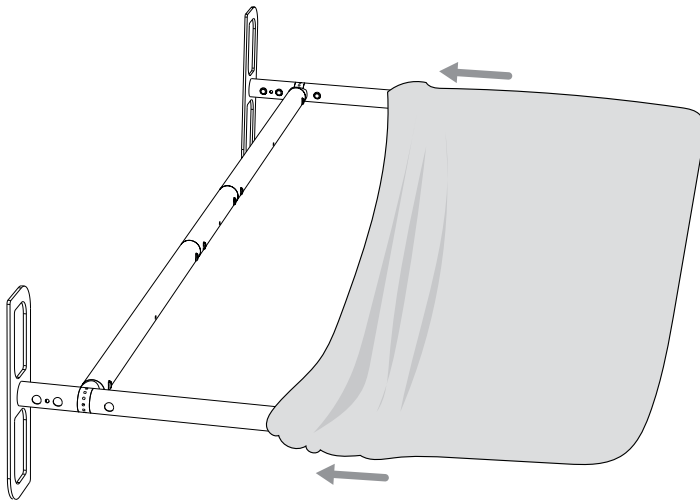
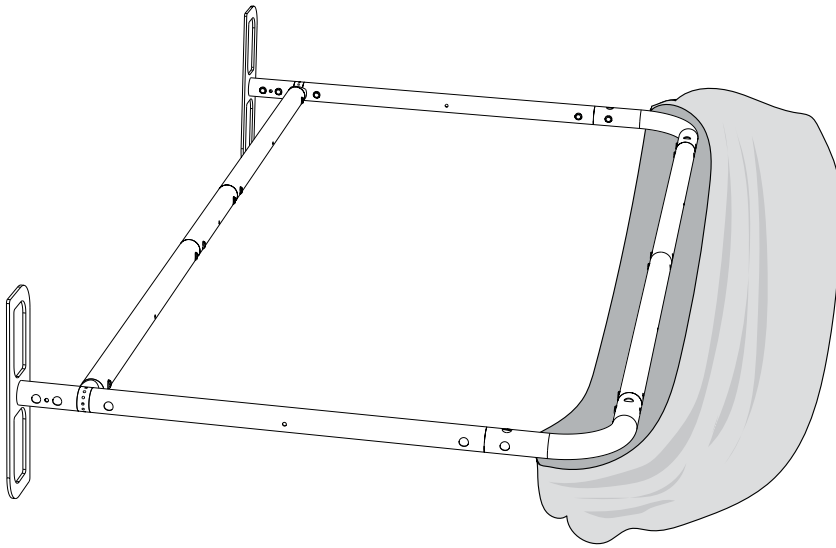

ASSEMBLED VIEW:

