

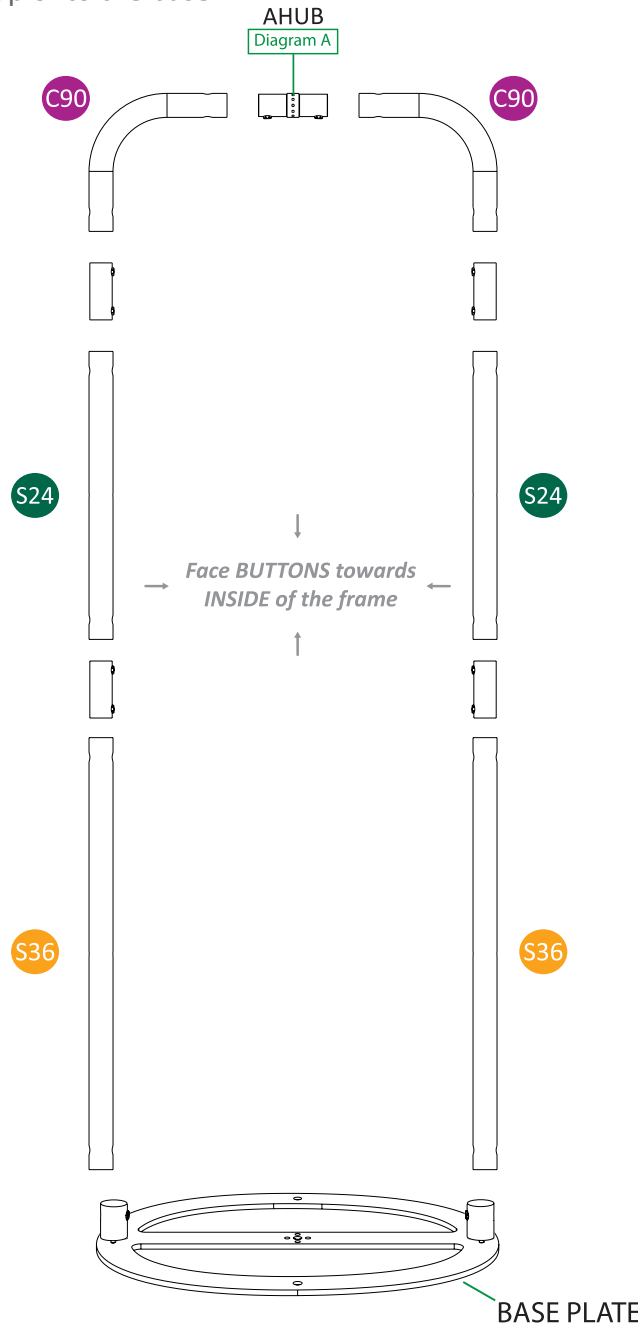

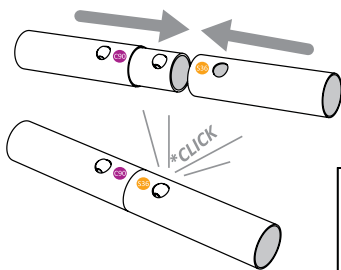

STEP 1. Layout all the parts on the floor in this form. Assembly of the tubes will be flat on the floor. Then stand the frame up to snap onto the base.



STEP 2. Push the button with your thumb while sliding the tubes together. Twist as needed to click the button into the hole.

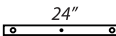
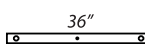

Parts Count:

-  **C90 (2x)**
-  **S24 (2x)**
-  **S36 (2x)**
-  **Diagram A (1x)**
- BASE PLATE (1x)**

STEP 3. To install the graphic, slide it over the top and pull downward from the sides to reach the bottom.

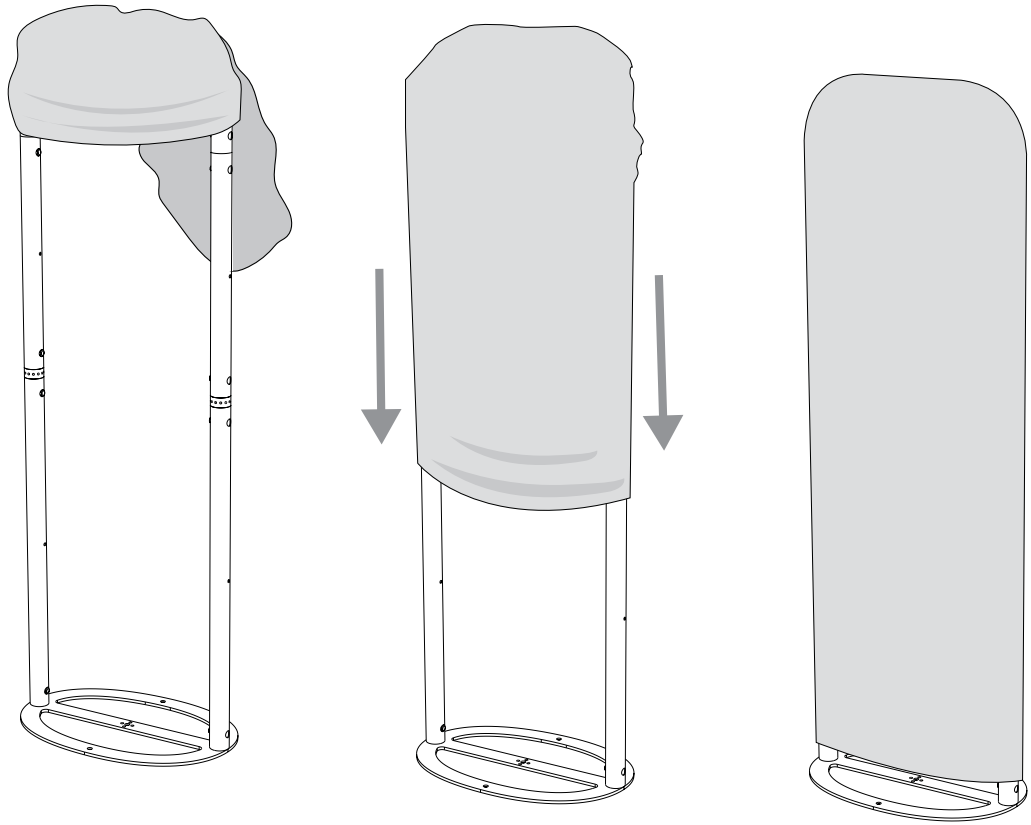

ASSEMBLED VIEW:

