

STEP 1. Layout all the parts on the floor in this form. Assembly will be done flat on the floor, not standing up. Organize the parts for the TOP frame and BASE frame.

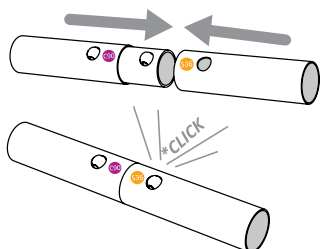
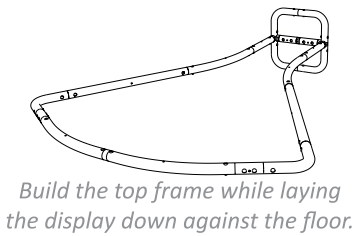
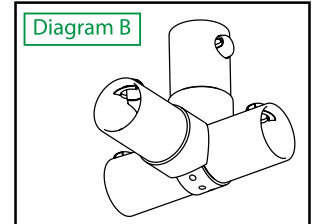
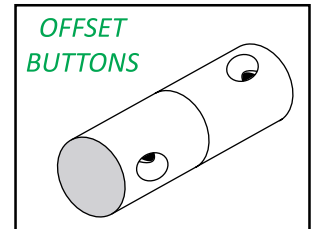
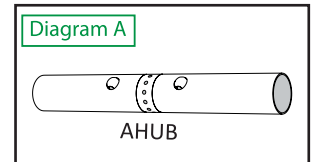
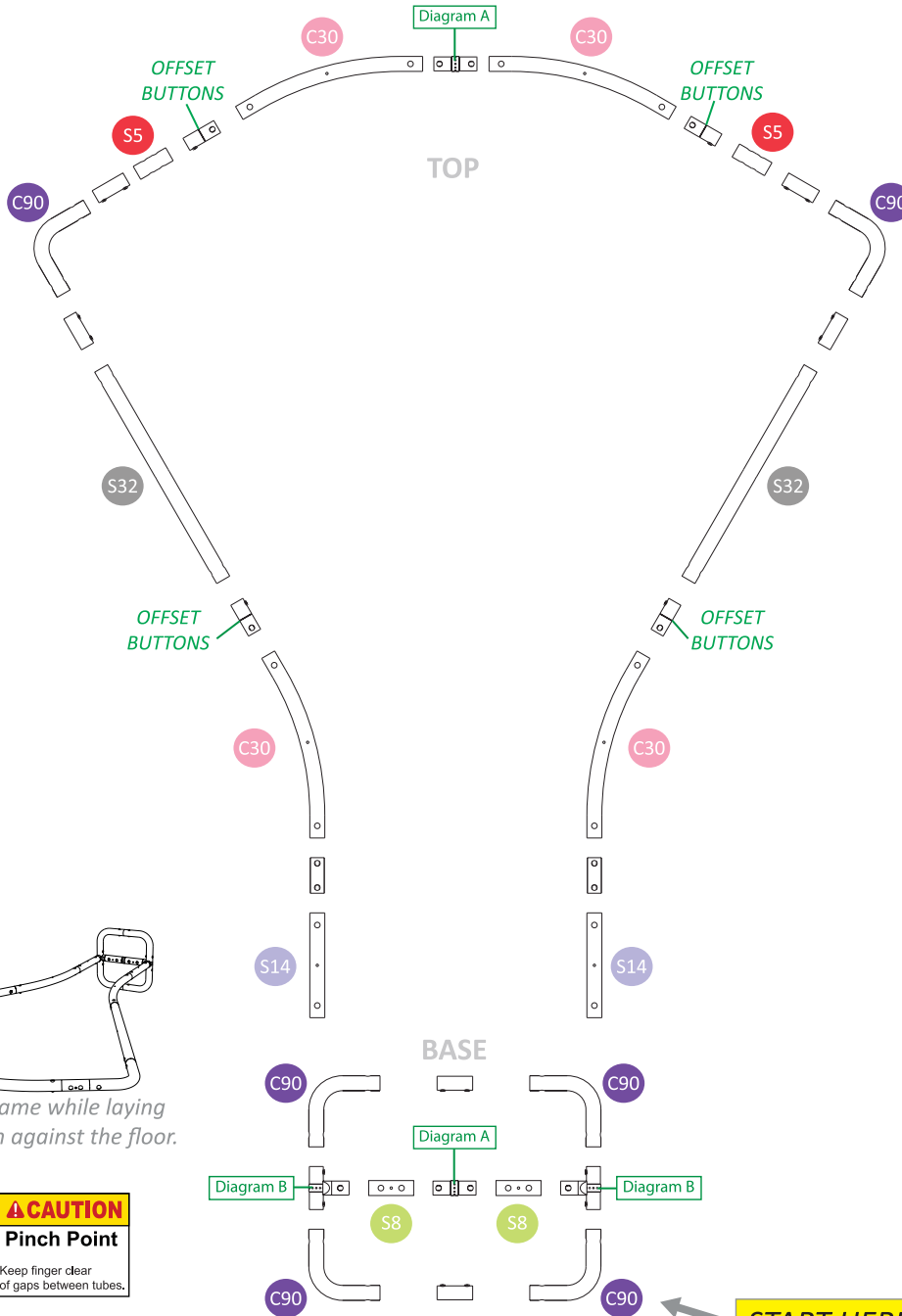

STEP 2. Start in this corner. Push the button with your thumb while sliding the tubes together. Twist as needed to click the button into the hole. Some buttons may already be inserted into one end of each tube. Stickers are next to the correct button hole. Build the BASE and the TOP separate.

Parts Count:

- C90 (6x)
- S5 (2x)
- S8 (2x)
- S14 (2x)
- S32 (2x)
- C30 (4x)
- OFFSET BUTTONS (4x)

Diagram A AHUB(2x)

Diagram B A60/A60/AHUB(2x)

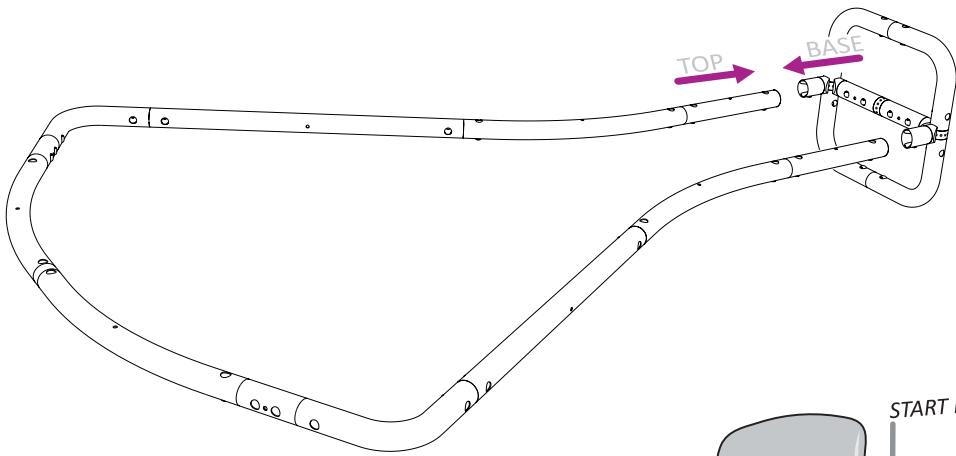

STEP 3. When all the tubes for the top and the tubes for the base are together, connect the top to the base.

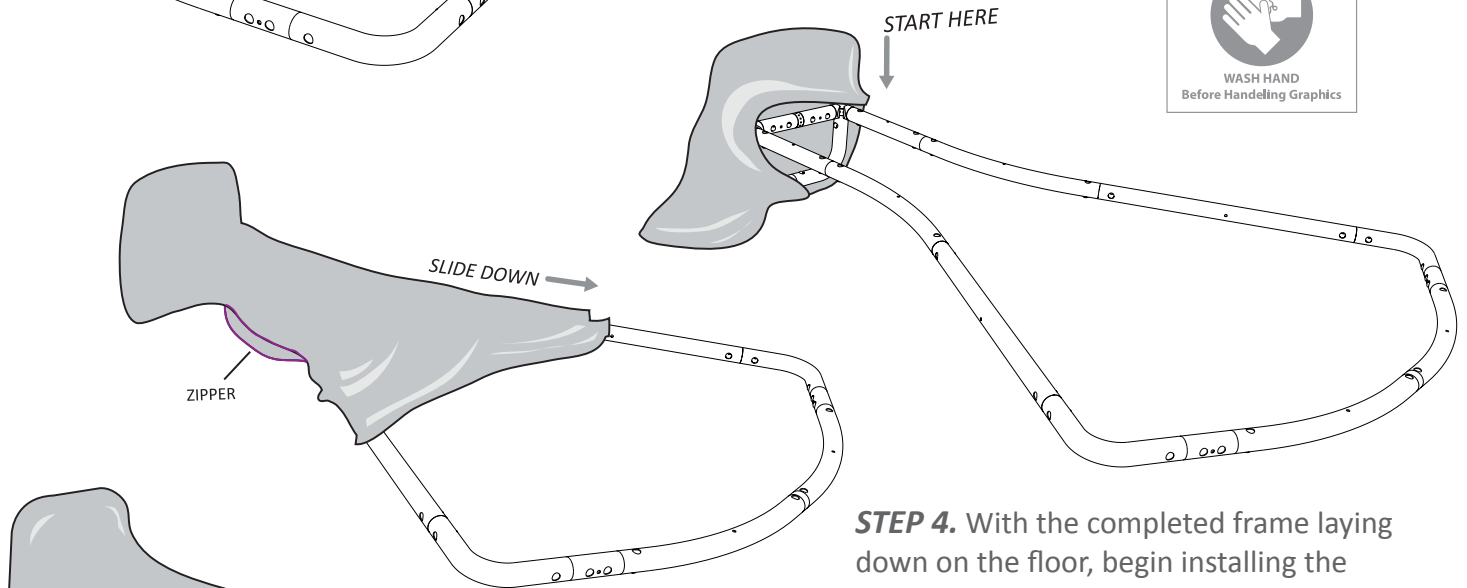

STEP 4. With the completed frame laying down on the floor, begin installing the graphics sliding the fabric over the bottom corners of the frame, like a pillow case. Switching from the right and left side, slide the fabric up a little bit at a time.

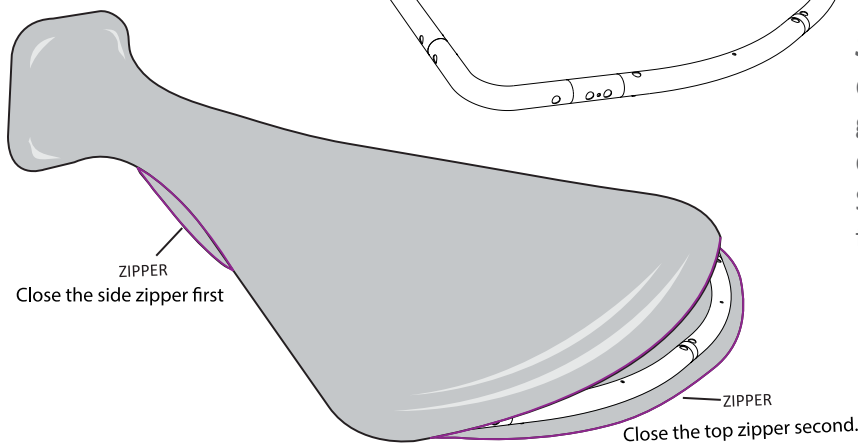

STEP 5. Once zipped closed, the display is ready to stand up. There are openings sewn at the top for installing lights. The electrical cords can be run inside of the graphics and out the bottom where the zipper shuts. Fit the light peg into the hole on top of the tube.

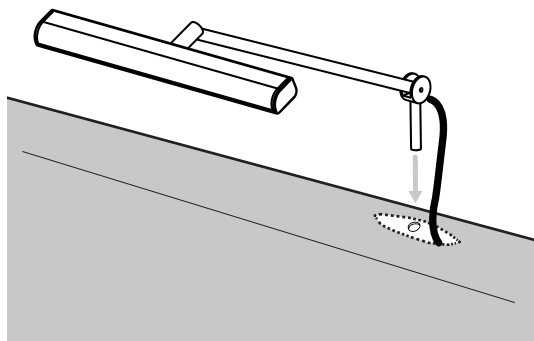

ASSEMBLED VIEW:

