

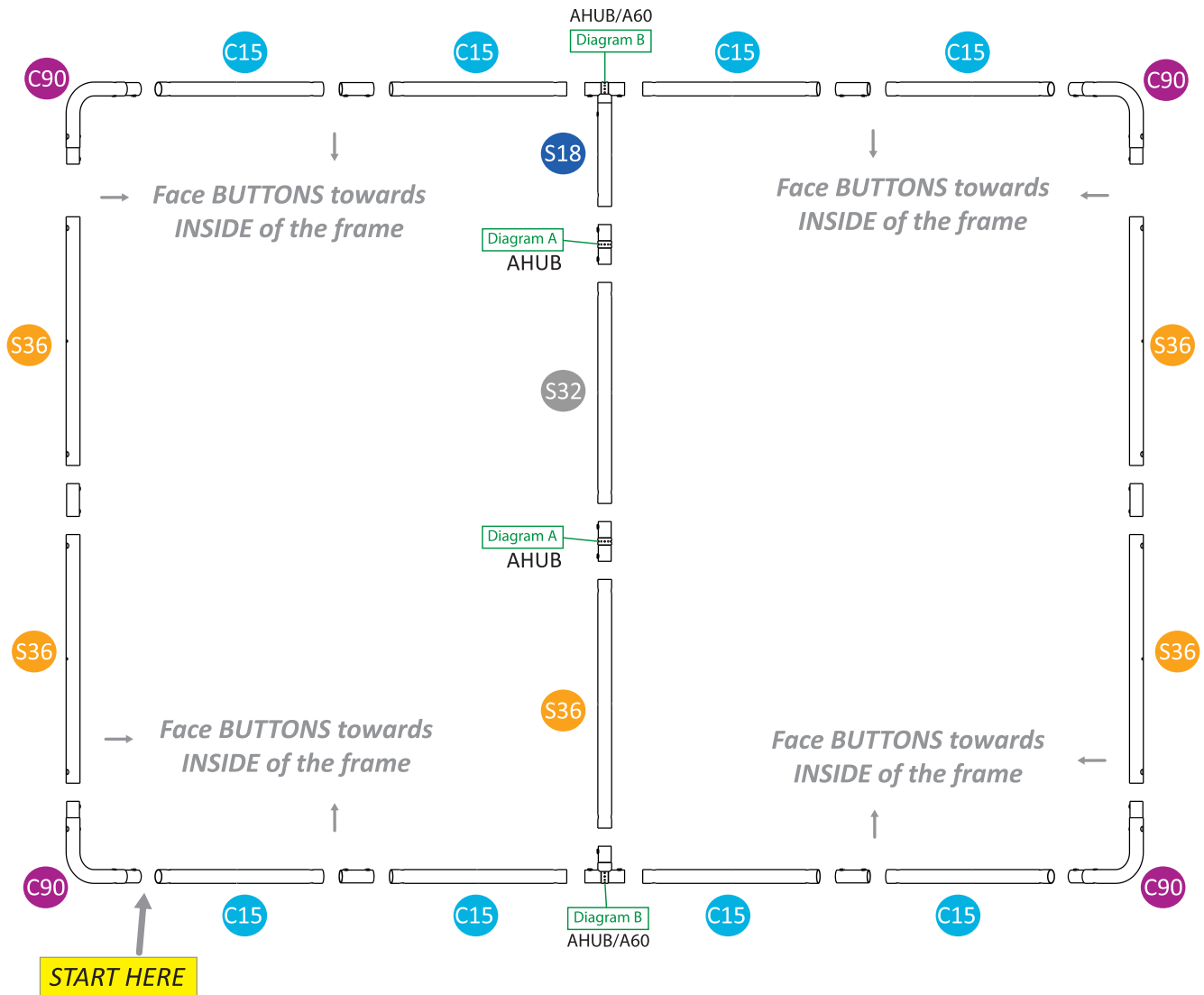

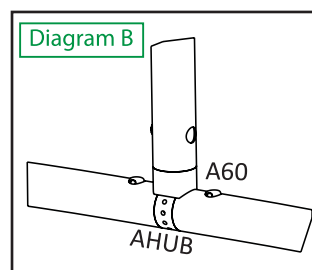

**STEP 1.** Layout all the parts on the floor in this form. Assembly will be done flat on the floor, not standing up.

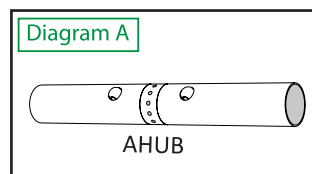
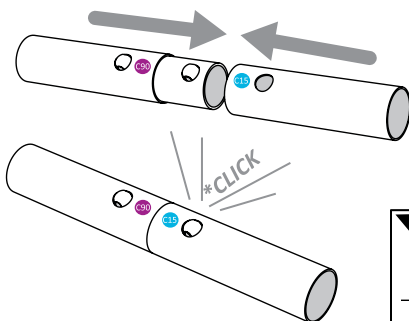

**STEP 2.** Start in this corner. Push the button with your thumb while sliding the tubes together. Twist as needed to click the button into the hole.

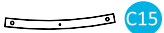
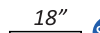
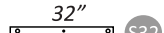
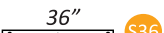

**Parts Count:**

-  **C90 (4x)**
-  **C15 (8x)**
-  **S18 (1x)**
-  **S32 (1x)**
-  **S36 (5x)**
-  **Diagram A AHUB (2x)**
-  **Diagram B A60/AHUB (2x)**

**STEP 3.** With the completed frame laying down on the floor, begin installing the graphics sliding the fabric over the top corners of the frame, like a pillow case. Switching from the right and left side, slide the fabric down a little bit at a time.

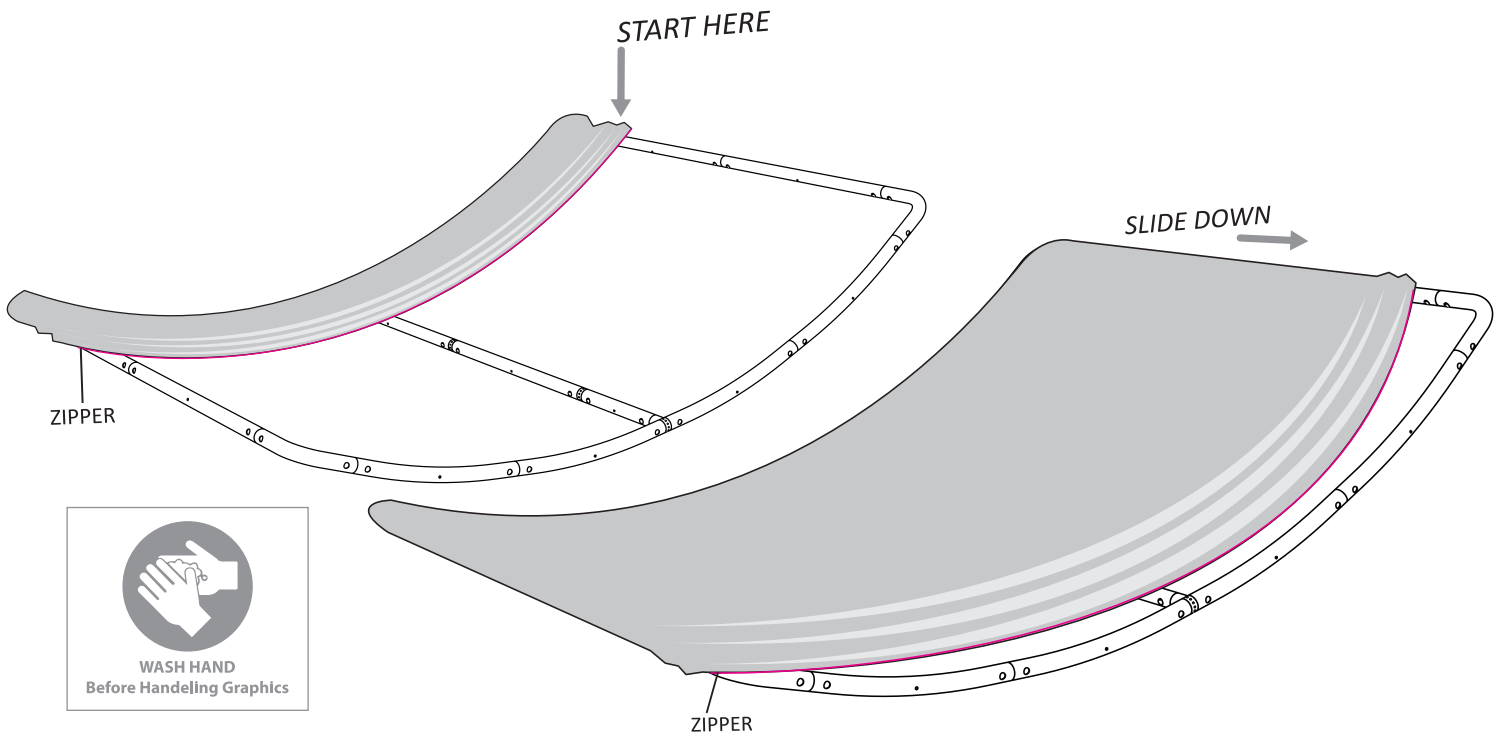

**STEP 4.** When the zipper reaches the bottom the fabric becomes tighter. Pull the fabric firmly with one hand around the bottom tube while zipping the bottom closed with the other hand.

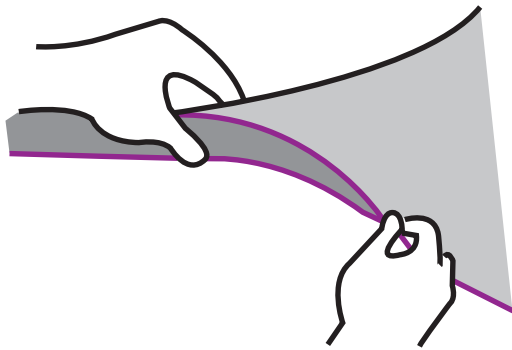

**STEP 5.** Once zipped closed, the display is ready to stand up. There are openings sewn at the top for installing lights. The electrical cords can be run inside of the graphics and out the bottom where the zipper shuts. Fit the light peg into the hole on top of the tube.

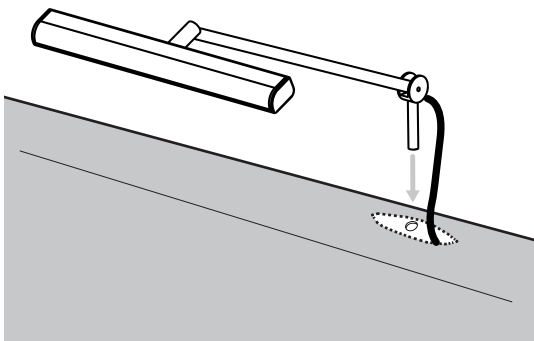

**ASSEMBLED VIEW:**

